

Article number: 392207501054016

Description: Worm Gear with Torque Limiter
W75 L1-UFC-10-P100B5

Measures

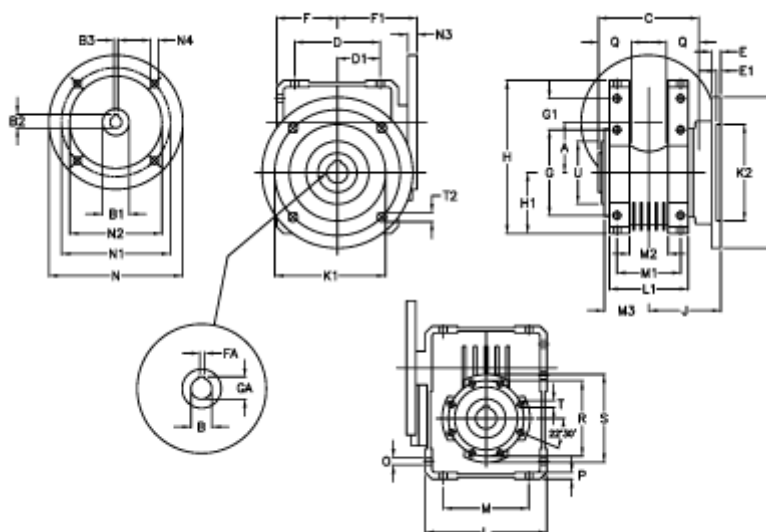

A = 75.00	E = 12	H = 220.5	M = 126	N4 = 12,5	U = 90
B = 30	E1 = 5	H1 = 87.0	M1 = 82	O = 10.5	
B1 E7 = 28	F = 87	J = 85.0	M2 = 44	P = 9	
B2 = 31.3	F1 = 120	K = 200	M3 = 58.5	Q = 40	
B3 H9 = 8	FA = 8	K1 = 165	N = 250	R = 110	
C = 127	G = 126	K2 = 130	N1 = 215	S = 125	
D = 109.5	G1 = 46.5	L = 174	N2 = 180	T = M8x14	
D1 = 46.5	GA = 33.3	L1 = 104	N3 = 13.0	T2 = 12.5	